

Custom Gas Blocks













Features:

- A cost effective alternative to adding new medical gas outlets
- Adds flexibility in moving your gas distribution closer to the patient
- Eliminates wear-and-tear on gas outlets
- Suited for all gases
- Compatible with all medical gas outlets
- Can be fitted into any equipment rail or mounting hardware
- Double and triple gas options available for multiple servicing to patients
- Various configurations available to meet specific requirements
- Meets all healthcare regulations











Amico Gas Blocks are designed to accommodate gas specific supply fittings that can be connected to a source outlet via a hose assembly, providing an easy and effective solution to expanding the gas distribution system within the hospital environment.

Single Gas Block









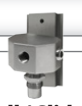

OXYGEN (O₂)

						
		Wall / Slide	Vertical	Amico	Fairfield	DIN 25
	DISS	GWS-PLDCPL-DMUO	GVS-PLDCPL-DMUO	GAS-PLDCPL-DMUO	GFS-PLDCPL-DMUO	GE1S-PLDCPL-DMUO
	Ohmeda Compatible	GWS-PLOFPL-DMUO	GVS-PLOFPL-DMUO	GAS-PLOFPL-DMUO	GFS-PLOFPL-DMUO	GE1S-PLOFPL-DMUO
	Chemetron Compatible	GWS-PLCFPL-DMUO	GVS-PLCFPL-DMUO	GAS-PLCFPL-DMUO	GFS-PLCFPL-DMUO	GE1S-PLCFPL-DMUO
	Puritan Bennett Compatible	GWS-PLPFPL-DMUO	GVS-PLPFPL-DMUO	GAS-PLPFPL-DMUO	GFS-PLPFPL-DMUO	GE1S-PLPFPL-DMUO
	Medstar Compatible	GWS-PLMFPL-DMUO	GVS-PLMFPL-DMUO	GAS-PLMFPL-DMUO	GFS-PLMFPL-DMUO	GE1S-PLMFPL-DMUO

MEDICAL AIR











						
		Wall / Slide	Vertical	Amico	Fairfield	DIN 25
	DISS	GWS-PLDCPL-DMUA	GVS-PLDCPL-DMUA	GAS-PLDCPL-DMUA	GFS-PLDCPL-DMUA	GE1S-PLDCPL-DMUA
	Ohmeda Compatible	GWS-PLOFPL-DMUA	GVS-PLOFPL-DMUA	GAS-PLOFPL-DMUA	GFS-PLOFPL-DMUA	GE1S-PLOFPL-DMUA
	Chemetron Compatible	GWS-PLCFPL-DMUA	GVS-PLCFPL-DMUA	GAS-PLCFPL-DMUA	GFS-PLCFPL-DMUA	GE1S-PLCFPL-DMUA
	Puritan Bennett Compatible	GWS-PLPFPL-DMUA	GVS-PLPFPL-DMUA	GAS-PLPFPL-DMUA	GFS-PLPFPL-DMUA	GE1S-PLPFPL-DMUA
	Medstar Compatible	GWS-PLMFPL-DMUA	GVS-PLMFPL-DMUA	GAS-PLMFPL-DMUA	GFS-PLMFPL-DMUA	GE1S-PLMFPL-DMUA

MEDICAL VACUUM











						
		Wall / Slide	Vertical	Amico	Fairfield	DIN 25
	DISS	GWS-PLDCPL-DMUV	GVS-PLDCPL-DMUV	GAS-PLDCPL-DMUV	GFS-PLDCPL-DMUV	GE1S-PLDCPL-DMUV
	Ohmeda Compatible	GWS-PLOFPL-DMUV	GVS-PLOFPL-DMUV	GAS-PLOFPL-DMUV	GFS-PLOFPL-DMUV	GE1S-PLOFPL-DMUV
	Chemetron Compatible	GWS-PLCFPL-DMUV	GVS-PLCFPL-DMUV	GAS-PLCFPL-DMUV	GFS-PLCFPL-DMUV	GE1S-PLCFPL-DMUV
	Puritan Bennett Compatible	GWS-PLPFPL-DMUV	GVS-PLPFPL-DMUV	GAS-PLPFPL-DMUV	GFS-PLPFPL-DMUV	GE1S-PLPFPL-DMUV
	Medstar Compatible	GWS-PLMFPL-DMUV	GVS-PLMFPL-DMUV	GAS-PLMFPL-DMUV	GFS-PLMFPL-DMUV	GE1S-PLMFPL-DMUV

Double Gas Block











OXYGEN (O₂)

		 Wall / Slide	 Vertical	 Amico	 Fairfield	 DIN 25
	DISS	GWD-PLDCPL-DMUO	GVD-PLDCPL-DMUO	GAD-PLDCPL-DMUO	GFD-PLDCPL-DMUO	GE1D-PLDCPL-DMUO
	Ohmeda Compatible	GWD-PLOFPL-DMUO	GVD-PLOFPL-DMUO	GAD-PLOFPL-DMUO	GFD-PLOFPL-DMUO	GE1D-PLOFPL-DMUO
	Chemetron Compatible	GWD-PLCFPL-DMUO	GVD-PLCFPL-DMUO	GAD-PLCFPL-DMUO	GFD-PLCFPL-DMUO	GE1D-PLCFPL-DMUO
	Puritan Bennett Compatible	GWD-PLPFPL-DMUO	GVD-PLPFPL-DMUO	GAD-PLPFPL-DMUO	GFD-PLPFPL-DMUO	GE1D-PLPFPL-DMUO
	Medstar Compatible	GWD-PLMFPL-DMUO	GVD-PLMFPL-DMUO	GAD-PLMFPL-DMUO	GFD-PLMFPL-DMUO	GE1D-PLMFPL-DMUO

MEDICAL AIR

		 Wall / Slide	 Vertical	 Amico	 Fairfield	 DIN 25
	DISS	GWD-PLDCPL-DMUA	GVD-PLDCPL-DMUA	GAD-PLDCPL-DMUA	GFD-PLDCPL-DMUA	GE1D-PLDCPL-DMUA
	Ohmeda Compatible	GWD-PLOFPL-DMUA	GVD-PLOFPL-DMUA	GAD-PLOFPL-DMUA	GFD-PLOFPL-DMUA	GE1D-PLOFPL-DMUA
	Chemetron Compatible	GWD-PLCFPL-DMUA	GVD-PLCFPL-DMUA	GAD-PLCFPL-DMUA	GFD-PLCFPL-DMUA	GE1D-PLCFPL-DMUA
	Puritan Bennett Compatible	GWD-PLPFPL-DMUA	GVD-PLPFPL-DMUA	GAD-PLPFPL-DMUA	GFD-PLPFPL-DMUA	GE1D-PLPFPL-DMUA
	Medstar Compatible	GWD-PLMFPL-DMUA	GVD-PLMFPL-DMUA	GAD-PLMFPL-DMUA	GFD-PLMFPL-DMUA	GE1D-PLMFPL-DMUA

MEDICAL VACUUM

		 Wall / Slide	 Vertical	 Amico	 Fairfield	 DIN 25
	DISS	GWD-PLDCPL-DMUV	GVD-PLDCPL-DMUV	GAD-PLDCPL-DMUV	GFD-PLDCPL-DMUV	GE1D-PLDCPL-DMUV
	Ohmeda Compatible	GWD-PLOFPL-DMUV	GVD-PLOFPL-DMUV	GAD-PLOFPL-DMUV	GFD-PLOFPL-DMUV	GE1D-PLOFPL-DMUV
	Chemetron Compatible	GWD-PLCFPL-DMUV	GVD-PLCFPL-DMUV	GAD-PLCFPL-DMUV	GFD-PLCFPL-DMUV	GE1D-PLCFPL-DMUV
	Puritan Bennett Compatible	GWD-PLPFPL-DMUV	GVD-PLPFPL-DMUV	GAD-PLPFPL-DMUV	GFD-PLPFPL-DMUV	GE1D-PLPFPL-DMUV
	Medstar Compatible	GWD-PLMFPL-DMUV	GVD-PLMFPL-DMUV	GAD-PLMFPL-DMUV	GFD-PLMFPL-DMUV	GE1D-PLMFPL-DMUV

Triple Gas Block



OXYGEN (O₂)

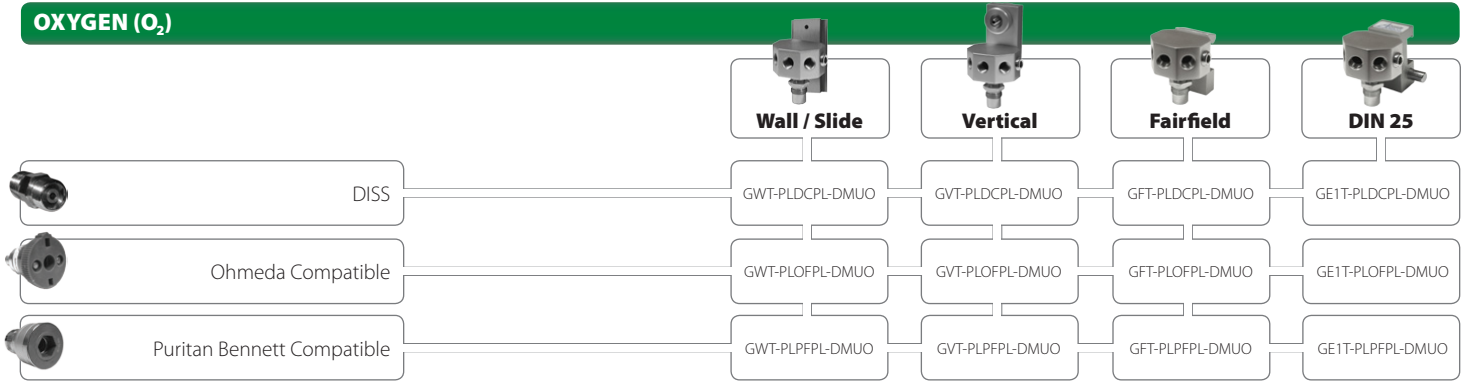

MEDICAL AIR

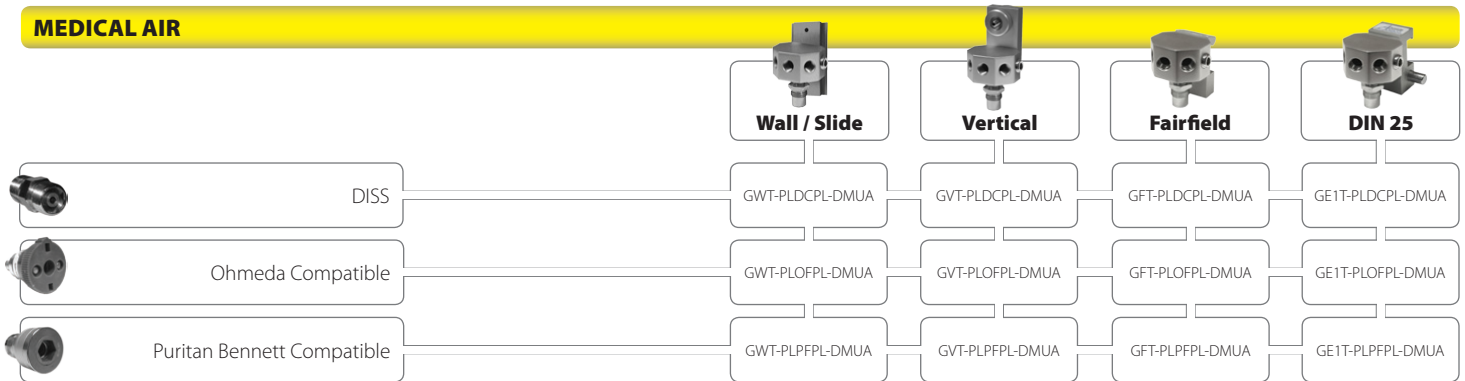

Horizon[®] Gas Block



Features:

- Color coded for easy gas identification
- Design insures maximum flow
- Can be repaired by the factory
- Standard 6ft conductive hose, custom lengths available upon request
- Compatible with Hill-Rom's Horizon[®] headwalls only
- International connections available upon request

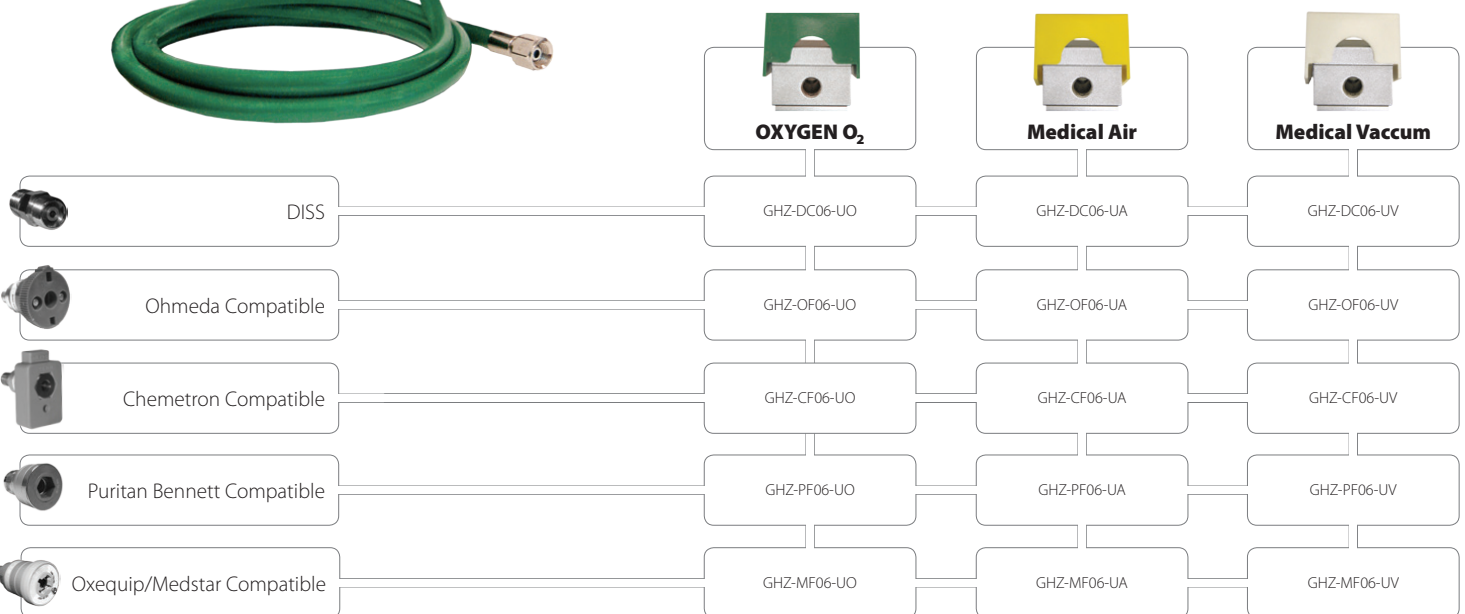

Relocate a Gas Connection

Move a medical gas connection to any desired location

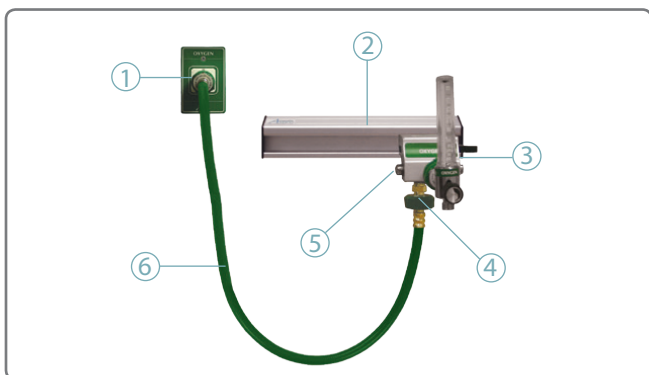

- ① Medical Gas Source
- ② Accessory Mounting Rail
- ③ Outlet from Gas Block Fittings
- ④ DISS Inlet to Gas Block
- ⑤ Plugged End Cap
- ⑥ Hose Assembly

Outlet Expansion

Add multiple connections using one source

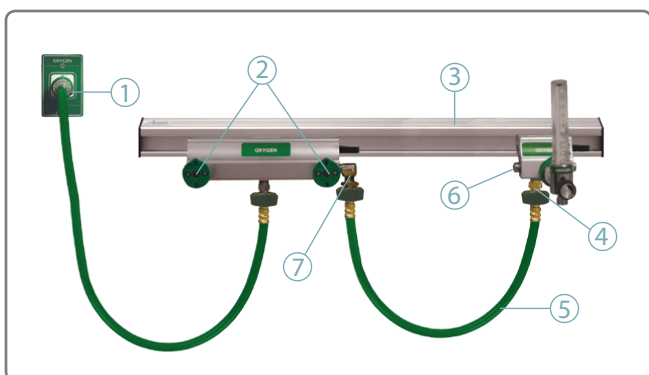

- ① Medical Gas Source
- ② Outlet from Gas Block Fittings
- ③ Accessory Mounting Rail
- ④ DISS Inlet to Gas Block
- ⑤ Hose Assembly
- ⑥ Plugged End Cap
- ⑦ DISS Power Take-off (Optional On All Gas Blocks)

Double Your Service

Connect to one existing outlet and service two different areas within a room

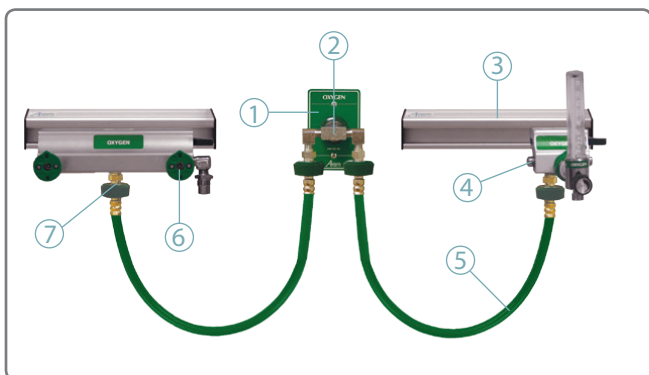

- ① Medical Gas Source
- ② "Y" Connector
- ③ Accessory Mounting Rail
- ④ Plugged End Cap
- ⑤ Hose Assembly
- ⑥ Outlet from Gas Block Fittings
- ⑦ DISS Inlet to Gas Block

Add One More

Add multiple gas blocks while keeping the existing outlet functioning

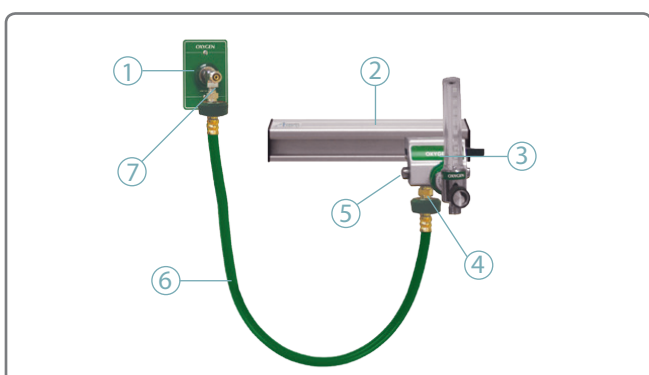

- ① Medical Gas Source
- ② Accessory Mounting Rail
- ③ Outlet from Gas Block Fittings
- ④ DISS Inlet to Gas Block
- ⑤ Plugged End Cap
- ⑥ Hose Assembly
- ⑦ "T" Connector



Hose Assemblies

- Connects medical gas blocks to a source
- Custom made to order

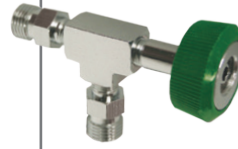

"T" Connector

- Allows for the existing gas outlet to remain in use while adding a second gas channel



Slides

- Conveniently mounts your canister suction ring bracket

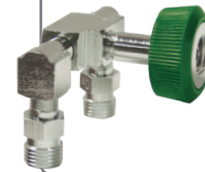

"Y" Connector

- Connects to the medical gas source for dual gas distribution

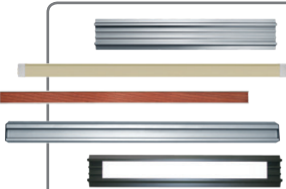

Rails

- Wide range of equipment rails designed to mount gas blocks for enhanced productivity and organization



Canisters & Canister Holders

- Disposable and reusable canisters available
- Ring bracket and canister sold separately
- 1200cc, 2000cc, and 3000cc size available



Equipment Roll Stands

- Used to mount gas blocks for added portability and versatility



Flowmeters & Vacuum Regulators

- Complete line of medical gas secondary equipment available

Please visit www.amico.com for more information on our gas blocks.



Distributed By:

