



Installation & Operating Instructions for Genesys® Analog Series Manifolds



Models NPCU & TMCU



Model TMLU

Contents

Features & Benefits	3
Introduction	4
General Instructions	4
Installation	
Control Cabinet	5
Headers	5
Plumbing	6
Electrical	8
Headers, Pigtails & Cylinders	10
Start Up & Testing Procedures	12
Model TML Emergency Reserve	13
Cylinder Replacement & Handling	14
Line Delivery Pressure Adjustment	14
Replacement Parts	15
Trouble Shooting Guide	17
General Maintenance	18
Appendix A Technical Specifications	19
Appendix B Models NPC & TMC Piping Schematic	20
Appendix C Model TML Piping Schematic	21
Appendix D Models NPC & TMC Wiring Schematic	22
Appendix E Model TML Wiring Schematic	23
Appendix F Model TMC Heater Wiring Schematic	24
Warranty	25
Technical Assistance	1-888-769-7979

Features & Benefits

- **Fully automatic changeover**
 - No valves or levers to reset after each changeover.
- **Field upgradeable design**
 - Kits allow unit to be changed from - i.e. cylinders to portable bulk or from standard flow to high flow or from lower delivery pressure to higher delivery pressure
- **400 psig pressure differential rated solenoid valve**
- **Exclusive single solenoid pressure differential rated changeover on cylinder x cylinder models**
- **Circuit board triggers secondary use alarm**
- **Easy to service layout/design**
- **Circuit board incorporates LEDs**
 - Easily visible even in poor lighting conditions
- **Analog gauges provided**
- **Built in DISS gas specific emergency feed port**
- **Built in emergency reserve bank ports**
- **Input power 120 VAC, 50 to 60 Hz**
 - Single point connection, even for units with heaters
- **Dual line pressure regulators available**
 - Make unit NFPA 99 compliant
- **Gas specific header bar with integral check valves and cylinder pigtail assemblies**
- **Variety of header configurations available to meet the available space requirements of your installation**
- **Optional part# PX-88-1075 single point vent kit available for NPCU models**
- **Optional part# PX-17-0169 and PX-17-0271 union assembly vent kits available for all models**

Introduction

Powerex manifolds are cleaned for use with oxygen. Each system is tested for changeover, triggering of secondary in use alarm, leakage and flow. Each unit is designed and prepared for the indicated gas service. Powerex manifolds are built in accordance with the National Fire Protection Association and Compressed Gas Association guidelines.

Warranty

All Powerex manifolds are warranted against defects in material and workmanship for the period of one year from date of purchase. All circuit boards are warranted against defects in material and workmanship for the period of three years from date of purchase.

General Instructions/Location & Shelter

Manifolds should be installed in accordance with guidelines stated by the National Fire Protection Association, the Compressed Gas Association, OSHA, and all applicable local codes. Central supply systems and cylinders should not be placed in a location where the temperature will exceed 125°F (51.6°C) or fall below -20°F (-29°C). A manifold placed in an open location should be protected against weather conditions. During winter, protect the manifold from ice and snow. In summer, shade the manifold and cylinders from continuous exposure to direct sunlight.

Leave all protective covers in place until their removal is required for installation. This precaution will keep moisture and debris from the piping interior.

CAUTION

Failure to follow the following instructions can result in personal injury or property damage:

- *Never permit oil, grease, or other combustible materials to come in contact with cylinders, manifold, and connections. Oil and grease may react with explosive force when ignited while in contact with some gases – particularly oxygen and nitrous oxide.*
- *Cylinder and master valves should always be opened very slowly. Heat of recompression may ignite combustible materials creating an explosive force.*
- *Pigtails should never be kinked, twisted, or bent into a radius smaller than 3 inches. Mistreatment may cause the pigtail to burst.*
- *Do not apply heat. Oil and grease may react with explosive force when ignited while in contact with some gases – particularly oxygen and nitrous oxide.*
- *Cylinders should always be secured with racks, chains, or straps. Unrestrained cylinders may fall over and damage or break off the cylinder valve which may propel the cylinder from its current position.*
- *Oxygen manifolds and cylinders should be grounded. Static discharges and lightning may ignite materials in an oxygen atmosphere, creating a fire or explosive force.*
- *Welding should not be performed near nitrous oxide piping. Excessive heat may cause the gas to dissociate, creating an explosive force.*
- *Remove all protective caps prior to assembly. The protective cap may ignite due to heat of recompression in an oxygen system.*

Control Cabinet Installation

- Determine and mark the vertical center line for installation of the manifold control cabinet.
- If you wish to place cylinders under the manifold cabinet, measure from the floor to a point 79" in height above the finished floor of this vertical line. Using a level, mark a horizontal line at this point extending approximately 7" to the left and 7" to the right of center. This line indicates the location for the bottom two mounting bolts of the Z mounting bracket. Mounting the Z bracket @ 79" aff* will result in the bottom of the manifold cabinet being 60" aff – allowing cylinders to be placed under the manifold cabinet. If you do not wish to place cylinders under the manifold cabinet, measure from the floor to a point 58 ½" aff and follow the same steps above.
- Mount the Z mounting bracket to the wall using fasteners suitable for the type of wall construction.
- Temporarily hang the manifold cabinet on the Z bracket just installed, mating it with the Z bracket on the back of the manifold cabinet. Mark the locations of the two lower cabinet mounting holes on the wall.
- Remove the manifold cabinet and install female portion of suitable fasteners for lower cabinet mounting holes.
- Re-hang the manifold cabinet and install suitable fasteners in the lower cabinet mounting holes.

* aff = above finished floor

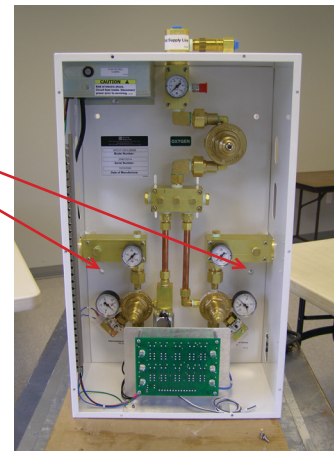
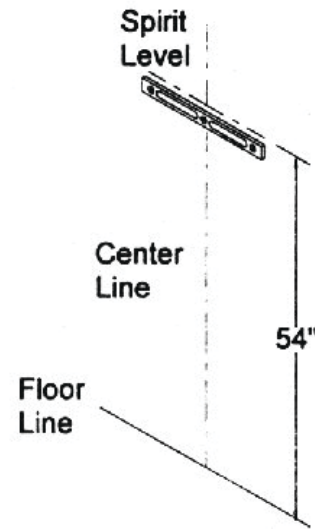

Header Installation

- Attach the headers to the union on each side of the manifold control cabinet. Using a level, mark the placement of mounting brackets while keeping the header on a horizontal plane.
- Remove the U-bolt assemblies from the header mounting brackets. Position the brackets so that the top of the bracket is aligned with the bottom of the headers and is centered between the cylinder connections. The end bracket should be placed as close to the last cylinder as possible to provide the most support and stability.

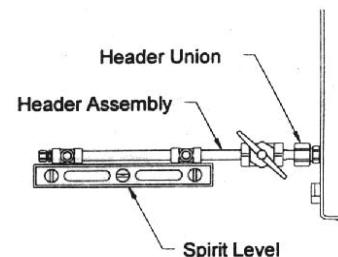

- Mark the mounting hole and install fasteners suitable for type of wall construction.
- Fit the U-bolt over the header piping and tighten the two mounting nuts.

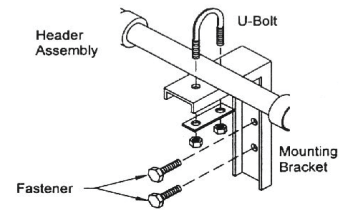

Plumbing

- The outlet of the manifold is located at the top center of the unit as shown here. The outlet connection is ½ NPT female. A ½ NPT male union should be installed between the outlet of the manifold cabinet and the pipeline system. This union is available as part of an accessory kit from Powerex (part # PX-88-1075).
- NPC models include a PX-48-0023 ball valve ½ M NPT x ¾ extension tube.
- The intermediate relief valves on the NPC model have been plumbed together. The 88-1075 Single Point Vent Kit should be installed between the intermediate relief valves and the relief (vent) pipeline system(s) for all indoor medical applications in order to be compliant with NFPA 99.
- The TMC models do not include the pre-plumbing of the intermediate relief valves. This plumbing would need to be added before the 88-1075 kit could be used.
- Plumbing for TMC models shown at right. Vent lines, (provided by plumber), shown in dotted lines.
- Plumbing for TML models shown below. Vent lines, (provided by plumber), shown in dotted lines.

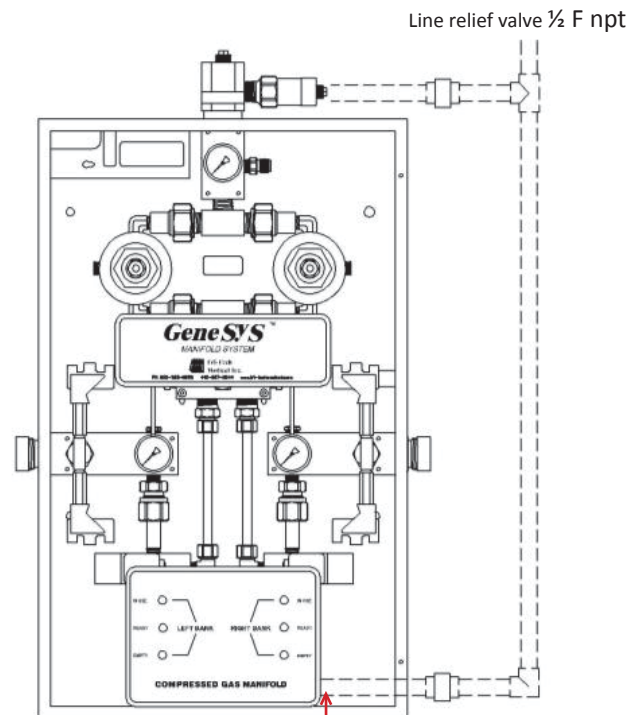

Intermediate relief connections from both primary regulators connected to a common vent line with the line relief valve. 88-1075 Single Point Vent kit shown as dotted lines.

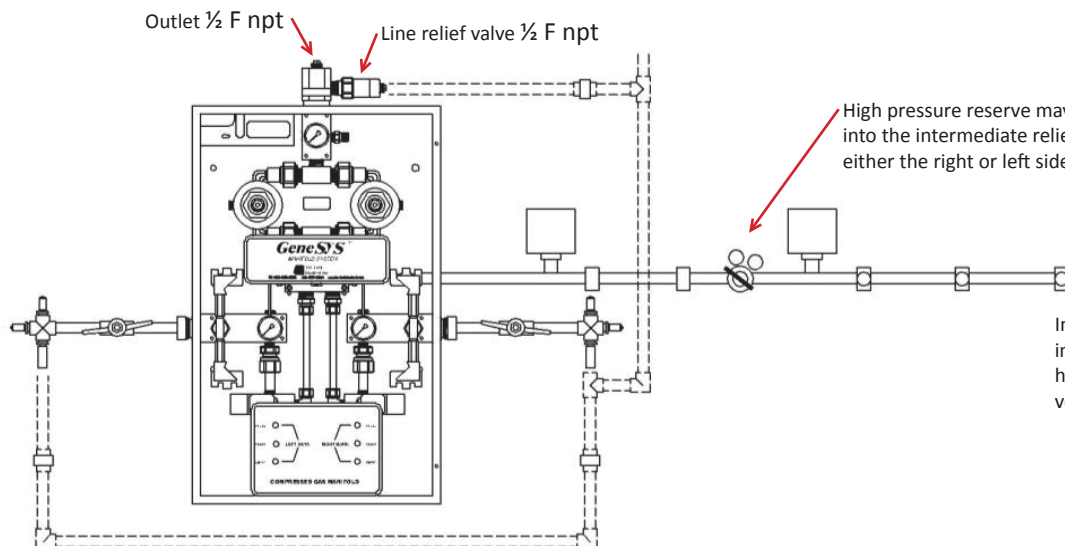

High pressure reserve may be plumbed into the intermediate relief valve from either the right or left side of the cabinet.

Intermediate relief connections from both intermediate relief valves (located on the headers) may be connected to a common vent line with the line relief valve.

NFPA 99 compliant TML
(shown without vent piping)

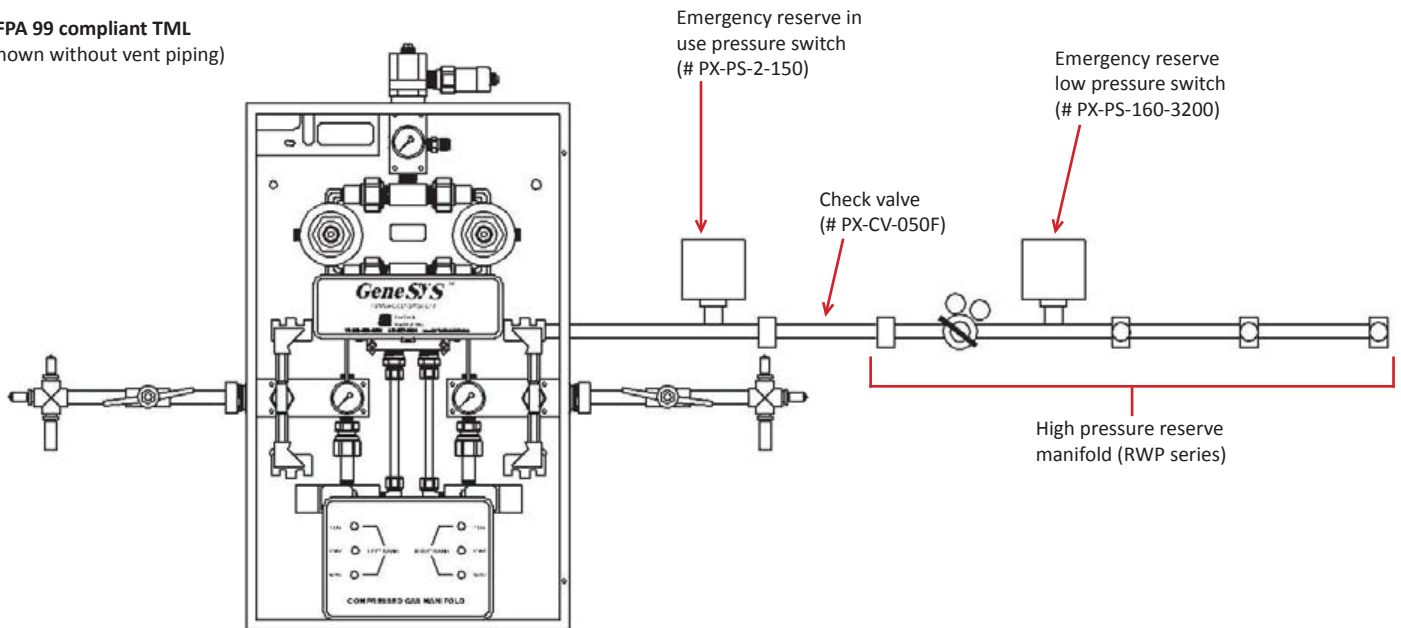

- In addition to connecting the left & right primary and secondary portable bulk vessel supply banks, the TML models must also have a high pressure reserve bank of cylinders connected to the cabinet, a check valve, an “Emergency Reserve in Use” and an “Emergency Reserve Low” pressure switch to be in compliance with NFPA 99 guidelines.
- Slots have been provided on both the left and right sides of the control cabinet to allow for the high pressure reserve piping.
- A check valve (part # PX-CV-050F shown here) must be installed between the emergency reserve in use pressure switch and the high pressure reserve regulator.
- Part # PX-17-0169 union (sold separately) shown here.

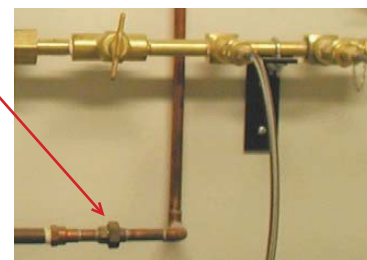

Electrical

- Use one of the two ½” conduit knock-outs provided located nearest to the top left corner of the cabinet to route conduit to supply 120 VAC to the power supply.

Note: Separate conduit should be used for low voltage wires (use knock outs provided on the left side of the box).

120-240 / 1 / 50 – 60 Hz may be used with all units. If the unit has heaters, the heaters only may be wired to 120/1/50-60. An additional transformer (sold separately part # 35-3004) is required to connect heaters to 240 VAC.

- Remove the power supply cover by loosening the screw located at the top of the cover and then sliding the power supply cover to the right until the screw is in the center of the tear-drop shaped cut out. Next, pull the cover forward until it clears the screw head and the fuse. **Note:** the bottom of the cover inserts into a slot in the back plate. Allow the cover to rest on the dual line regulator assembly plumbing just below the power supply.
- Route wires of proper gauge (per local building code requirement) through the power supply conduit, thru the grommet on the power supply bracket and into the terminal strip.
- Connect the 120 VAC facility emergency power source electrical wiring to the terminal strip provided on the front of the power supply mounting bracket (per photos right). (N = neutral, L = load, FG = field ground).
Note: The ground must be a solid earth ground with little or no resistance. A “noisy” earth ground may affect the digital display of the manifold.

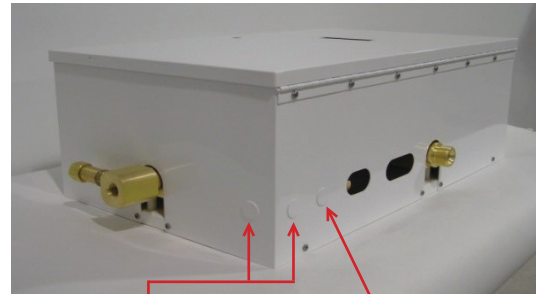

Conduit knockouts for 120 VAC Conduit knockout for low voltage alarm signals

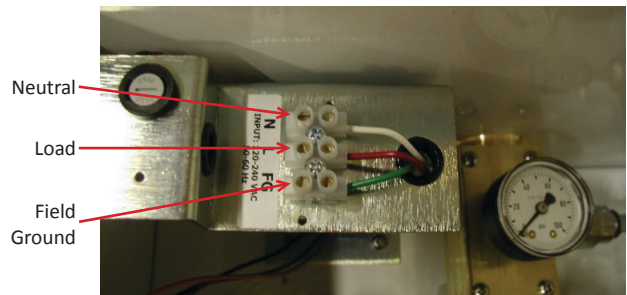

Caution: Never connect or disconnect any electrical components with the power on. This may result in damage to components and is not covered under warranty.

- Wires for remote alarms should be brought into the cabinet thru conduit or shielded cables (check local code requirements) thru the knockouts on the left side of the cabinet shown here.

Note: Separate conduit should be used for high voltage wires – never run low voltage wires in the same conduit as high voltage wires.

- If you are installing a model NPC (cylinder x cylinder) cabinet to meet NFPA 99 there are three alarm signals required per NFPA 99, High Line Pressure, Low Line Pressure and Reserve in Use. The NPC circuit board will trigger the “Secondary in Use” alarm. An optional hi/low pressure switch Part # PX-PS-1-80 may be installed in order to receive high & low line pressure alarm signals.

Note: The hi/low pressure switch would be wired directly to the master alarm panels – not to the manifold circuit board.

- 3. Remote alarm wires for the “Secondary in Use” alarm may be connected to a terminal strip located just to the right of the circuit board. The wires (labeled A1 & A2) connecting this terminal strip to the circuit are connected to dry contacts on the circuit board. No voltage higher than 24 VDC should be connected to these terminals.

Note: The remote alarm terminals are normally closed when the gas pressure is in the normal range. The hi/low set points pre-set in the manifold are as per the following charts:

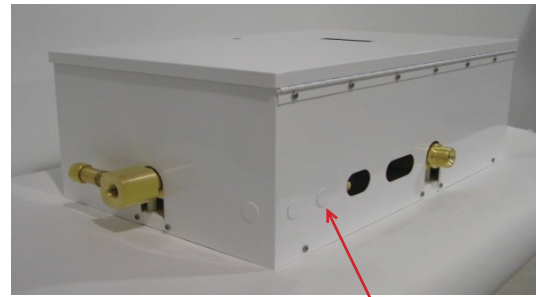

Knockout for low voltage remote alarm wiring

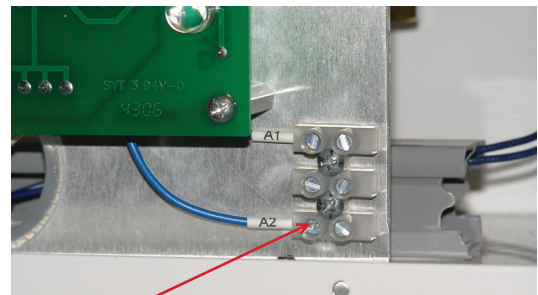

Secondary in use “changeover” remote dry contact connections

Pressure Settings for NPC & TMC Models

(all pressures in psig)

Maximum Inlet Pressure	Normal Delivery Press	Line Relief Setting	Secondary In Use Set Point
3,000	50	75	135 left bank / 110 right bank
3,000	80	150	235 left bank / 220 right bank
3,000	170	250	235 left bank / 220 right bank

Pressure Settings for TML Models

(all pressures in psig)

Maximum Inlet Pressure	Normal Delivery Press	Line Relief Setting	Secondary In Use Set Point
400	50	75	60 both banks
400	80	150	135 both banks
400	170	250	190 both banks

Installing Headers & Attaching Cylinders

NPC & TMC Models

- Match the gas service indicated by the labels on the control cabinet with the gas service indicated by the label on the headers and the CGA fittings on the header and the pigtails. It is critical that the headers, pigtails and control cabinet gas service/CGA match.

CGA 320 = CO₂ Carbon Dioxide

CGA 326 = N₂O Nitrous Oxide

CGA 346 = Medical Air

CGA 540 = Oxygen

CGA 580 = N₂ Nitrogen
or Argon

- Using two 1 ½" wrenches, one on the inlet block inside the control cabinet and the other on the union nut, tighten the headers to the control cabinet.
- Check the master valves to be certain they are open (turn counter-clockwise to open). (Note: the master valve should always be left open. It is to be used only in the event of an emergency).
- Attach the pigtails to the header check valve outlets using two 1 1/8" open end wrenches.
- SLOWLY open all cylinder valves (turn counter-clockwise to open). Check all cylinder and pigtail connections for leaks using an oxygen safe leak test solution (any bubbles forming around connections indicate leakage).
- Check all cylinder and pigtail connections for leaks using an oxygen safe leak test solution (any bubbles or foam forming around connections indicate leakage).

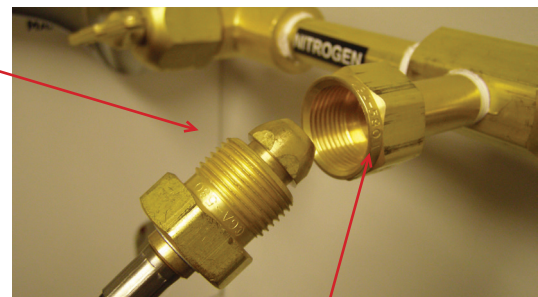
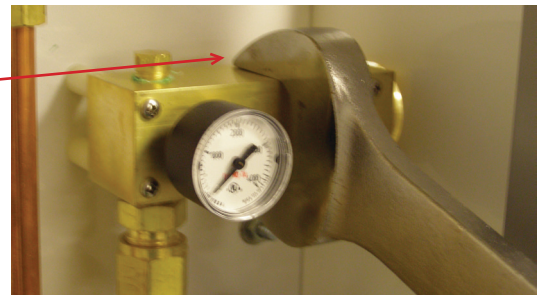
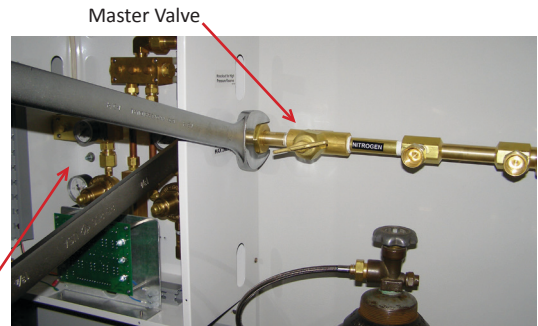

CGA #s are marked here

Installing Pigtails & Attaching Cylinders

TML Models

- A typical header for a model TML portable bulk vessel vapor withdrawal manifold is shown here. CGA connections are stamped on both the header fittings and on the pigtail fittings. It is critical that these fittings match the gas service of the control cabinet.

- CGA 320 = CO2 Carbon Dioxide
- CGA 326 = N2O Nitrous Oxide
- CGA 346 = Medical Air
- CGA 540 = Oxygen
- CGA 580 = N2 Nitrogen or Argon

- Connect the end of the pigtail with the CGA fitting to the “Use” valve mating fitting on the portable bulk vessel. Open the use valve. The pressure building valve or regulator should be turned on or opened for all vessels connected to the manifold (both service and reserve banks). Allow approximately 1 hour for the portable bulk vessel(s) to build pressure.
- Check all cylinder and pigtail connections for leaks using an oxygen safe leak test solution (any bubbles or foam forming around connections indicate leakage).
- Verify that the pressure being supplied to the manifold cabinet exceeds the minimum inlet pressure requirements in the table below.



CGA connections for pigtails with gas tight cap, chain, and hook rings

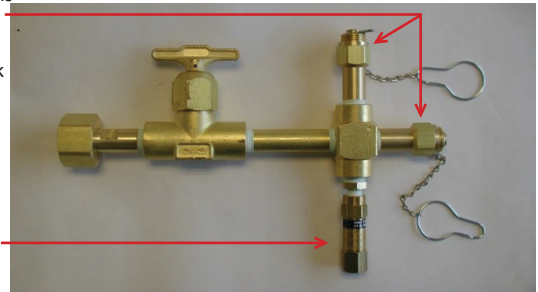

Intermediate pressure relief valve x 3/8 F npt



Minimum Inlet Pressure Requirements for TML Manifold

(all pressures in psig)

Manifold Delivery Pressure	Minimum Inlet Pressure	Relief Valve Setting on Vessel
50	150	235
80	150	235
170	250	350

Start Up & Testing Procedures

- Turn on the power to the unit. Both the left & right bank Red (Depleted) LED's should be illuminated and the left and right bank Green (In Use) and Yellow LED's (Ready) should be extinguished. If the manifold is wired to a remote alarm (master alarm) – the Secondary in Use alarm will be activated.
- SLOWLY open one cylinder valve on the left bank. The left bank pressure gauge (inside the cabinet) should display the full pressure of the cylinder. The Red (Empty) LED for the left bank should have extinguished and the Green (In Use) LED should be illuminated. The right bank Red (Empty) LED should remain illuminated and if the manifold is wired to a remote alarm (master alarm) – the Secondary in Use alarm will be activated.
- SLOWLY open one cylinder valve on the right bank. The right bank pressure gauge (inside the cabinet) should display the full pressure of the cylinder. The Red (Empty) LED for the right bank should have extinguished and the Yellow (Ready) LED should have illuminated. If the manifold is wired to a remote alarm (master alarm) – the Secondary in Use alarm will not be activated.
- Turn off all open left bank cylinder valves. Create a slight flow of gas in the delivery pipeline system. The left bank pressure gauge should fall and the control automatically switches over to the right bank. Delivery pressure remains constant. The left bank Red (Empty) LED will illuminate. The Secondary in Use alarm should activate on the remote or master alarm(s).
- SLOWLY reopen the cylinders on the left bank. The left bank pressure gauge should return to full pressure. The left bank yellow (Ready) LED will illuminate. Simultaneously the left bank red (Empty) will extinguish. All remote Secondary in Use alarms will be canceled. Repeat steps 2 – 4 substituting right for left to simulate a changeover from the right bank to the left bank.

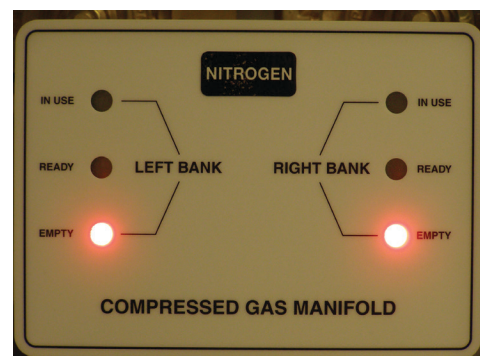
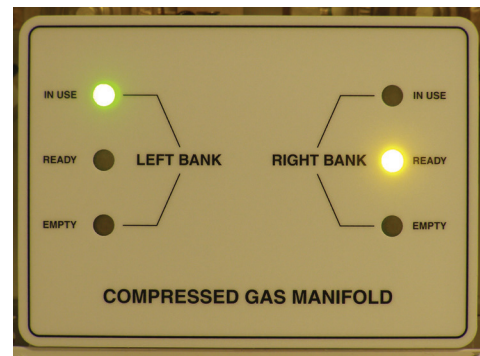
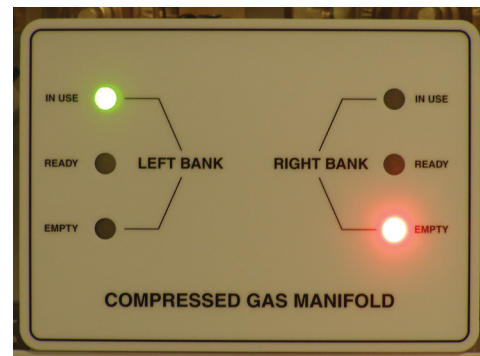
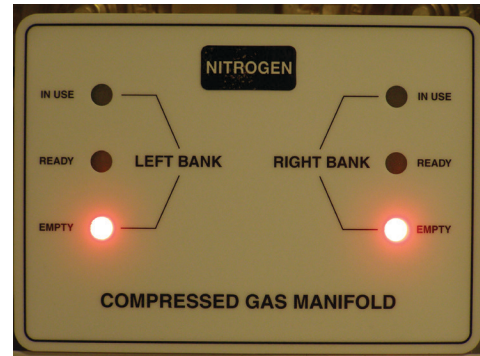

NFPA 99 compliant TML
(shown without vent piping)

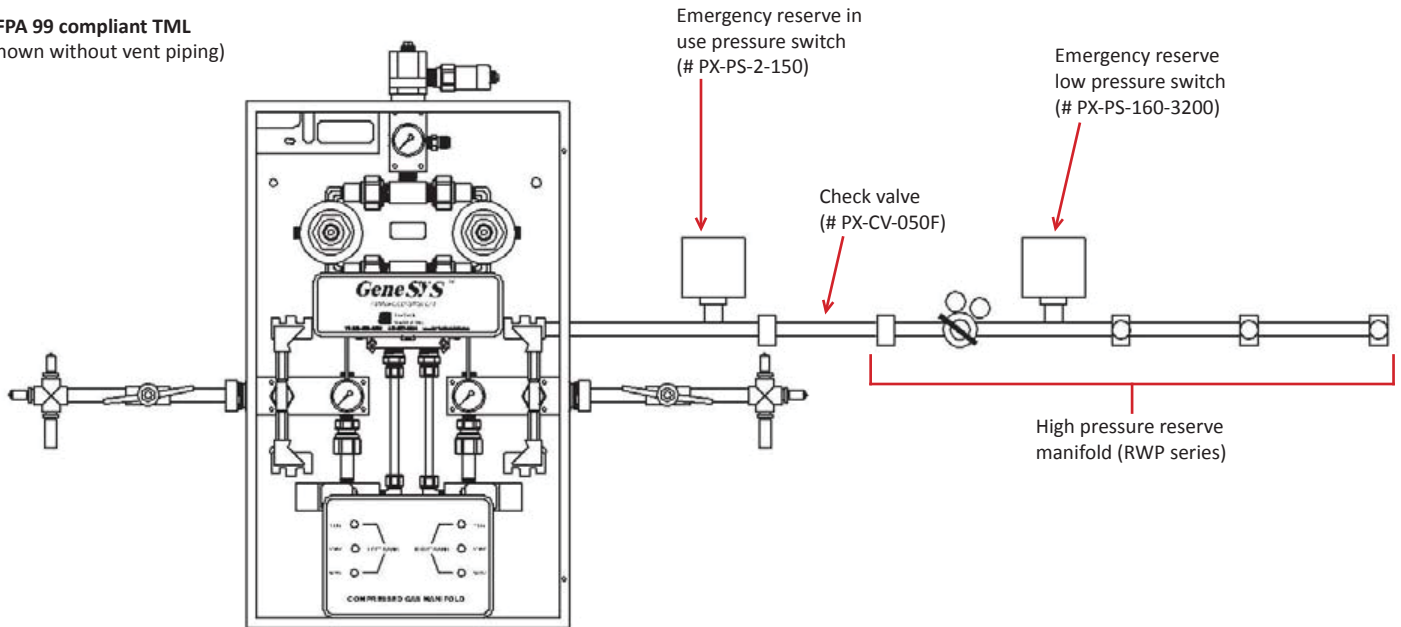

Model TML – Emergency Reserve Pressure Settings & Alarm Set Points

- NFPA 99 requires five alarms for portable bulk manifold systems with high pressure reserve; high line pressure, low line pressure, secondary in use, emergency reserve in use and emergency reserve low.
- The high and low line pressure alarms are generated by a pressure switch which is mounted on the downstream side of the source valve. NFPA 99 also requires a gauge and a DISS union assembly on the downstream side of the source valve. This assembly (high/low switch, gauge and DISS union is available as an assembly. The part #'s are as follows:

Gas Service	Part #
Oxygen (O2)	PX-PST-24
Medical Air	PX-PST-16
Nitrous Oxide (N2)	PX-PST-04
Carbon Dioxide (CO2)	PX-PST-08
Nitrogen (N2)	PX-PSX-12

- The emergency reserve low bank pressure switch (part # PX-PS-160-3200) should be installed on the extra port on the RWP series manifold. This port is located prior (upstream) to the master valve and the regulator.
- The emergency reserve in use pressure switch (part # PX-PS-2-150) should be installed on copper tubing (provided by plumbing contractor) after (downstream) the check valve (part # PX-CV-050F).
- Refer to the chart below for information on setting the delivery (outlet) pressure of the emergency reserve regulator and emergency reserve in use and emergency reserve low pressure switches.

Manifold Delivery Pressure	Recommended Emergency Reserve Regulator Delivery Pressure Setting	Recommended Emergency Reserve in Use alarm set point	Pre-set* Emergency Reserve Low alarm set point
50 psig	65 psig	75 psig	1200 psig
80 psig	70 psig	80 psig	1200 psig
200 psig	170 psig	180 psig	1200 psig

*Emergency reserve low pressure switch (#PX-PS-160-3200) is shipped pre-set at approximately 1,200 psig. If desired, this switch may be re-set in the field at a different pressure setting.

Cylinder Replacement & Handling

- Close all cylinder valves on the depleted bank.
- SLOWLY loosen and remove the pigtail connection from the depleted cylinders.
- Remove depleted cylinders and replace protective caps.
- Place and secure full cylinders into position using chains, belts or cylinder stands.
- Remove protective cylinder caps from full replacement cylinders. With the valve outlet pointed away from all people in the area, slowly open each cylinder valve slightly to blow out any dirt or contaminants that may have become lodged in the cylinder valve.
- Connect pigtails to cylinder valves and tighten with wrench.
- SLOWLY turn each cylinder valve until each cylinder is fully on.
- Observe the following conditions: The red (Empty) LED is extinguished and the yellow (Ready) LED is illuminated and the remote reserve in use alarm is cancelled.
- The manifold supply bank is now replenished and automatically placed in “reserve”.



Line Delivery Pressure Adjustment

- Leave the manifold in full operational status.
- Create a flow condition in the delivery piping system. A DISS demand valve has been provided on the outlet block. Mating DISS fittings may be used to create a flow of gas within the manifold cabinet.
- The line pressure regulator(s) is located at the top of the manifold cabinet. Ball valves are provided only on models with dual line regulators on the inlet and outlet sides of each regulator determine which regulator is “on line” and which is “off line”. Note: when the ball valve handle is perpendicular to the pipeline, the ball valve is closed.
- Turn the T-bar handle clockwise to increase line pressure or counter-clockwise to decrease line pressure. It may be necessary to use a 3/4” open-end wrench, loosen the locknut on the adjusting screw (on high flow models only).
- After adjustment, retighten the locknut (on high flow models only) on the adjusting screw and close the cabinet door.

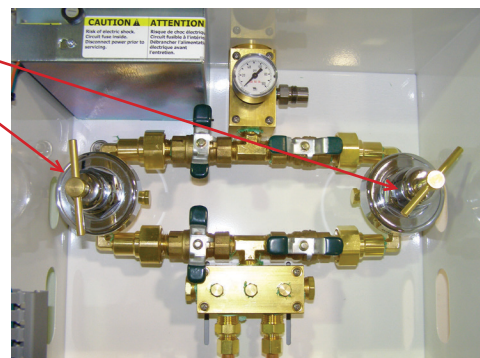
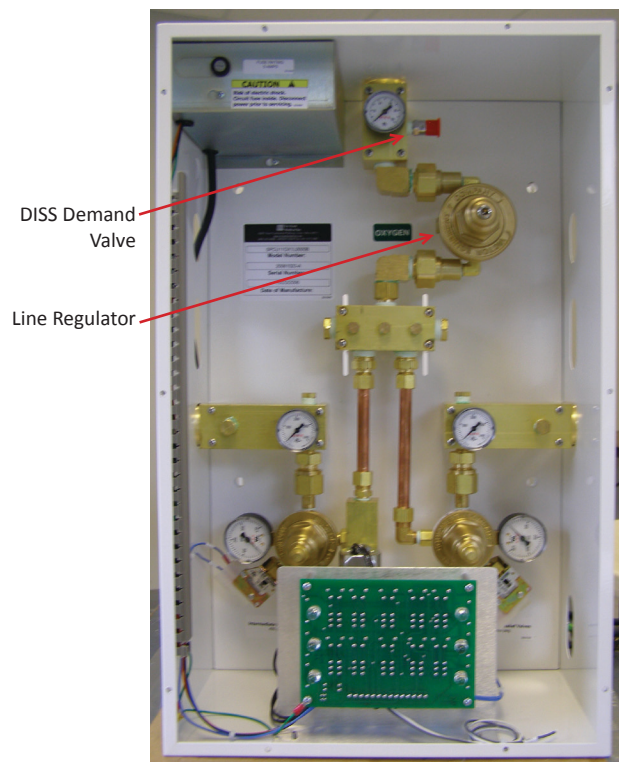

Replacement Parts & Accessories

Item	Part #	Description
Primary Regulator & Repair Kits	PX-68-0003R	0 – 300 psig delivery, 3,000 psig inlet, 6 port
	PX-68-0003RK	Rebuild kit for primary regulator 68-0003
Line Regulators & Repair Kits	PX-68-0017R	5 – 125 psig standard flow line regulator
	PX-68-0017RK	Rebuild kit for 5 - 125 standard flow line regulator 68-0017
	PX-68-0002R	5 – 125 psig high flow line regulator
	PX-68-0002RK	Rebuild kit for 5 - 125 high flow line regulator 68-0002
	PX-68-0001R	10 – 200 psig high flow line regulator
	PX-68-0001RK	Rebuild kit for 0 – 200 high flow line regulator 68-0001
Circuit Board	PX-35-1007R	Universal NPC, TMC & TML Manifold Circuit Board
Pressure Switches (in control cabinet)	PX-14-2013	NPC, TMC & TML Left Bank Pressure Switch
	PX-14-2014	NPC, TMC & TML Right Bank Pressure Switch
Pressure Switches (outside cabinet)	PX-PS-1-80	High/Low line pressure switch range 1 – 80 psig preset @ 40/60
	PX-PS-2-150	Emergency reserve in use switch range 2 – 150 psig
	PX-PS-10-250L	N2 Low line pressure switch range 10-250 psig preset @ 160 on fall
	PX-PS-10-250H	N2 High line pressure switch range 10-250 psig preset @ 200 on rise
	PX-PS-160-3200	Emergency reserve low switch range 160 – 3200 psig preset @ 1200
Pressure Switch, Gauge, DISS Assemblies (includes above appropriate pressure switch (switches 2 for N2) pre-assembled in a Tee or Cross with a 4" gauge & DISS union check valve	PX-PST-04	N2O
	PX-PST-08	CO2
	PX-PSX-12	N2
	PX-PST-16	Medical Air
	PX-PST-24	Oxygen
DISS Demand Check Union Assemblies	PX-PS-04	Nitrous Oxide ¼ M npt demand valve x 1/8 M npt nipple
	PX-PS-08	CO2 ¼ M npt demand valve x 1/8 M npt nipple
	PX-PS-12	N2 ¼ M npt demand valve x 1/8 M npt nipple
	PX-PS-16	Medical Air ¼ M npt demand valve x 1/8 M npt nipple
	PX-PS-24	Oxygen ¼ M npt demand valve x 1/8 M npt nipple
Solenoid Valves	PX-48-1007R	Used on TMC models for all gas services
	PX-48-1008R	Used on TML models for all gas services - left side
	PX-48-1009R	Used on TML models for all gas services - right side
Power Supply	PX-35-2013R	110 VAC / 24 & 5 VDC
Gauges (inside cabinet)	PX-14-1018	0 – 4,000 psig 1 ½" x 1/8 M npt center back
	PX-14-1016	0 – 400 psig 2" x ¼ M npt bottom port
	PX-14-1017	0 – 400 psig 1 ½" x 1/8 M npt center back
	PX-14-1009	0 – 300 psig 1 ½" x 1/8 M npt center back
	PX-14-1008	0 – 100 psig 1 ½" x 1/8 M npt center back
Gauges (outside cabinet)	PX-ZV300-5	0 – 100 psig 4" x ¼ M npt bottom port
	PX-ZV300-6	0 – 300 psig 4" x ¼ M npt bottom port
Relief Valves	PX-RV-22-075	75 psig x ½ M npt inlet
	PX-RV-22-150	150 psig x ½ M npt inlet
	PX-RV-22-250	250 psig x ½ M npt inlet
	PX-RV-11-400	400 psig x ¼ M npt inlet

Replacement Parts & Accessories (Continued)

Item	Part #	Description
Intermediate Check Valve	PX-17-4003R	½ M npt x ½ OD tube compression
Pigtails for cylinders	PX-20-1001	24" single loop rigid copper O2 – CGA 540
	PX-20-0001	24" Flexible stainless braided O2 - CGA 540
	PX-20-1002	24" single loop rigid copper N2O – CGA 326
	PX-20-0002	24" Flexible stainless braided N2O - CGA 326
	PX-20-0003	24" Flexible stainless braided CO2 – CGA 320
	PX-20-0004	24" Flexible stainless braided AIR – CGA 346
	PX-20-0005	24" Flexible stainless braided N2 or Ar – CGA 580
Pigtails for portable bulk vessels	PX-20-2001	72" Flexible with check valve – O2 – CGA 540
	PX-20-2002	72" Flexible with check valve – N2 or Ar – CGA 580
	PX-20-2003	72" Flexible with check valve – CO2 – CGA 320
	PX-20-2004	72" Flexible with check valve – N2O – CGA 326
Union	PX-17-0169	½" M npt x ½" M npt 3 piece union
Wall Brackets	PX-WB-1	Single cylinder wall bracket with chain
	PX-WB-2	Dual cylinder wall bracket with chain
Source Valve	PX-48-0023	Ball valve - 1/2 M NPT x 3/4 tube extension

Troubleshooting Guide

NOTE: Troubleshooting and repairs should be done by qualified personnel only.

Symptom	Probable Cause	Remedy or Check
Cabinet Indicator Lights		
No indicator lights on front panel illuminate when power is connected.	Power input	Check electrical power supply
	Blown fuse	Check fuses on power supply
	Internal wiring disconnected	Check all wiring connections
Red indicator lights are on but both banks are full	Master valve or cylinder valves on bank are closed	Open valves SLOWLY
	Pigtails are installed with check valves in wrong direction	Close cylinders and re-install pigtails in proper flow direction
	Bank pressure is not sufficient for logic board to place it in "In Use" or "Ready" status	Replace cylinders with full cylinders. Or, if using portable bulk vessels, open pressure building valve on vessel or replace portable bulk vessel with higher delivery pressure portable bulk vessel
	Primary regulators are out of adjustment	Adjust primary regulators – per manual
	Circuit board defective	Replace circuit board
Loss of Cylinder Contents		
Audible or inaudible gas leakage (origin unknown)	Leakage at manifold piping connections	Tighten, reseal or replace
	Leakage thru manifold solenoid vent / relief	Replace solenoid valve
	Regulator with bad seat	Rebuild or replace regulator
	Leaking gauge	Replace gauge
Venting at relief valve	Regulator set too high	Set delivery pressure per specifications
	Overpressure due to failed regulator seat	Rebuild or replace regulator
	Regulator freeze-up (N2O or CO2) / heater failure	Repair heater or add heater and consider adding additional cylinders
Left bank will not be placed into ready (Red/Empty status stays illuminated) when bank pressure is full	Left primary regulator is out of adjustment – set too low	Adjust left primary regulator – per manual
Right bank will not be placed into ready (Red/Empty status stays illuminated) when bank pressure is full	Right primary regulator is out of adjustment – set too low	Adjust right primary regulator – per manual
Both banks feeding	Leaking header/pigtail connection	Tighten fitting or re-tape with Oxygen safe Teflon tape (if npt fitting) and tighten.
	Leaking intermediate check valve	Replace check valve
	Leaking solenoid valve	Replace solenoid valve
	Model NPC & TMC – primary regulator(s) out of adjustment	Set delivery pressure to specifications per chart on page 20
	Model TML – inlet pressure to control cabinet is too low	Verify that minimum inlet pressure requirements are met
	Model TML – portable bulk venting	Gas usage not high enough to justify portable bulk reserve

Troubleshooting Guide (Continued)

NOTE: Troubleshooting and repairs should be done by qualified personnel only.

Symptom	Probable Cause	Remedy or Check
Both banks feeding (continued)	Model TML – gas flowing thru economizer circuit	This is normal when reserve bank pressure is 50 psig greater than service bank pressure – no correction needed to manifold control cabinet. May consider reducing size of banks if reserve bank is more than 35% depleted at time it is placed in service "In Use"
		If gas is flowing thru economizer when the reserve bank pressure is not 50 psig greater than service bank pressure – the economizer check valve needs to be replaced.
Changeover occurs, reserve in use alarm is triggered and then clears	Manifold is unable to support required flow	Increase manifold flow capacity (call factory for assistance)
	Model TML – portable bulk vessel(s) are unable to support required flow	Increase bank size. If using two or more portable bulk vessels per bank currently, connect pigtail(s) (no check valve) from vent to vent of all vessels on the same bank and open the vent valves. This will equalize the head pressure of the vessels and utilize the combined vaporization capacity – not just the capacity of the vessel with the highest delivery pressure set point.

General Maintenance

Control Cabinet

- Daily Record line and bank pressures
- Monthly Check regulators, compression fittings and valves for external leakage. Check valves for closure ability.
- Annually Check relief valve pressures. Check regulator seats.

Manifold Headers & Pigtails

- Daily Observe nitrous oxide and carbon dioxide systems for cylinder frosting or surface condensation. Should excessive condensation or frosting occur it may be necessary to increase manifold capacity.
- Monthly Inspect valves for proper closure. Check pigtails for cleanliness, flexibility, wear, leakage, and thread damage. Replace damaged pigtails immediately. Inspect header check valves for closure ability.
- Every 4 years Replace all pigtails

Appendix A

Manifold Specifications

Minimum Inlet Pressure:	Model NPC & TMC:	3000psig
	Model TML:	400psig
Operating Ambient Temperature range:	Model NPC & TMC:	0°F (-18°C) to 130°F (54.4°C) all gases except N2O & CO2
		20°F (-7°C) to 130°F (54.4°C) N2O & CO2
	Model TML:	-20°F (-29°C) to 130°F (54.4°C)

Storage Temperature: -20°C(-4°F) to +85°C(185°F)

AC Input: 120 volts AC – 50-60 Hz

Input Fuse: 5 amp input AC line fuse protects the input wiring to power supply

Power Consumption: 45W (0.4 amps using 120 VAC) maximum without heaters
50W (2.1 amps using 120 VAC) maximum with heaters

Pressure Measurement Accuracy: All gauges are 3/2/3 design. They are ± 3% of full scale in the first and last 1/3 of their range. They are ± 2% of full scale in the middle 1/3rd of their range.

Solenoid Valve: 24VDC – Normally Open (Valve opens when de-energized)

Control Cabinet Dimensions: Dimensions excluding inlet & outlet fittings
15 ¾" W x 24 ¾" H x 9 ¼" D
Dimensions including inlet & outlet fittings
17 ¼" W x 27" H x 9 ¼" D

Primary Regulator Settings (NPC & TMC Models)

NOTE: All settings done with 2,200 psig cylinder pressure and with slight gas flow thru the manifold. Primary regulator outlet pressure will vary with varying inlet pressures. (The outlet pressure will rise as the cylinder pressure decreases as much as 40 – 50 psig). All pressures shown in psig.

Normal Delivery Pressure (factory delivery pressure)	Left Primary Regulator Set Point	Right Primary Regulator Set Point
50	160	120
80	260	220
170	260	220

Appendix B

NPC & TMC Piping Schematic

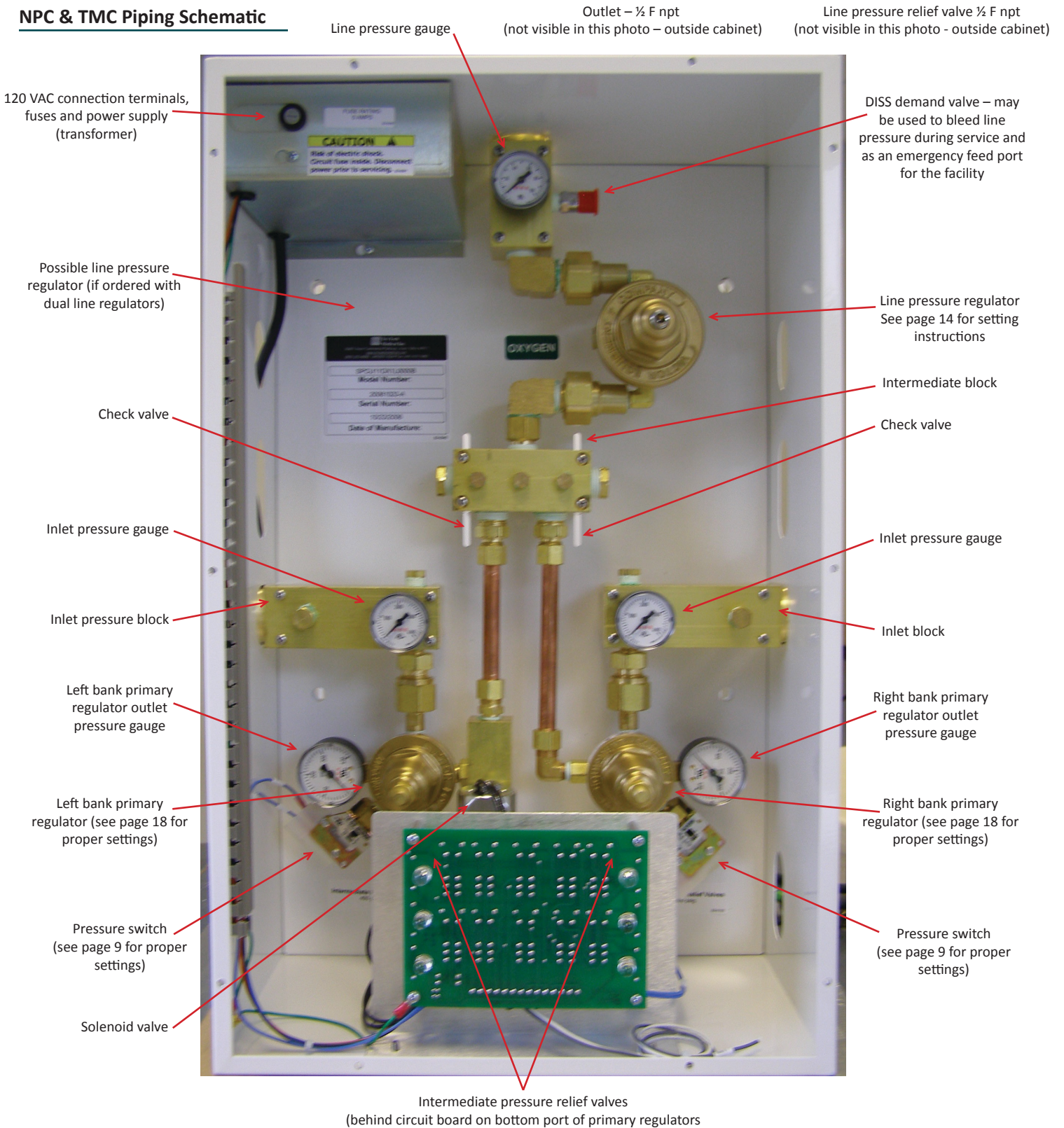

Appendix C

TML Piping Schematic

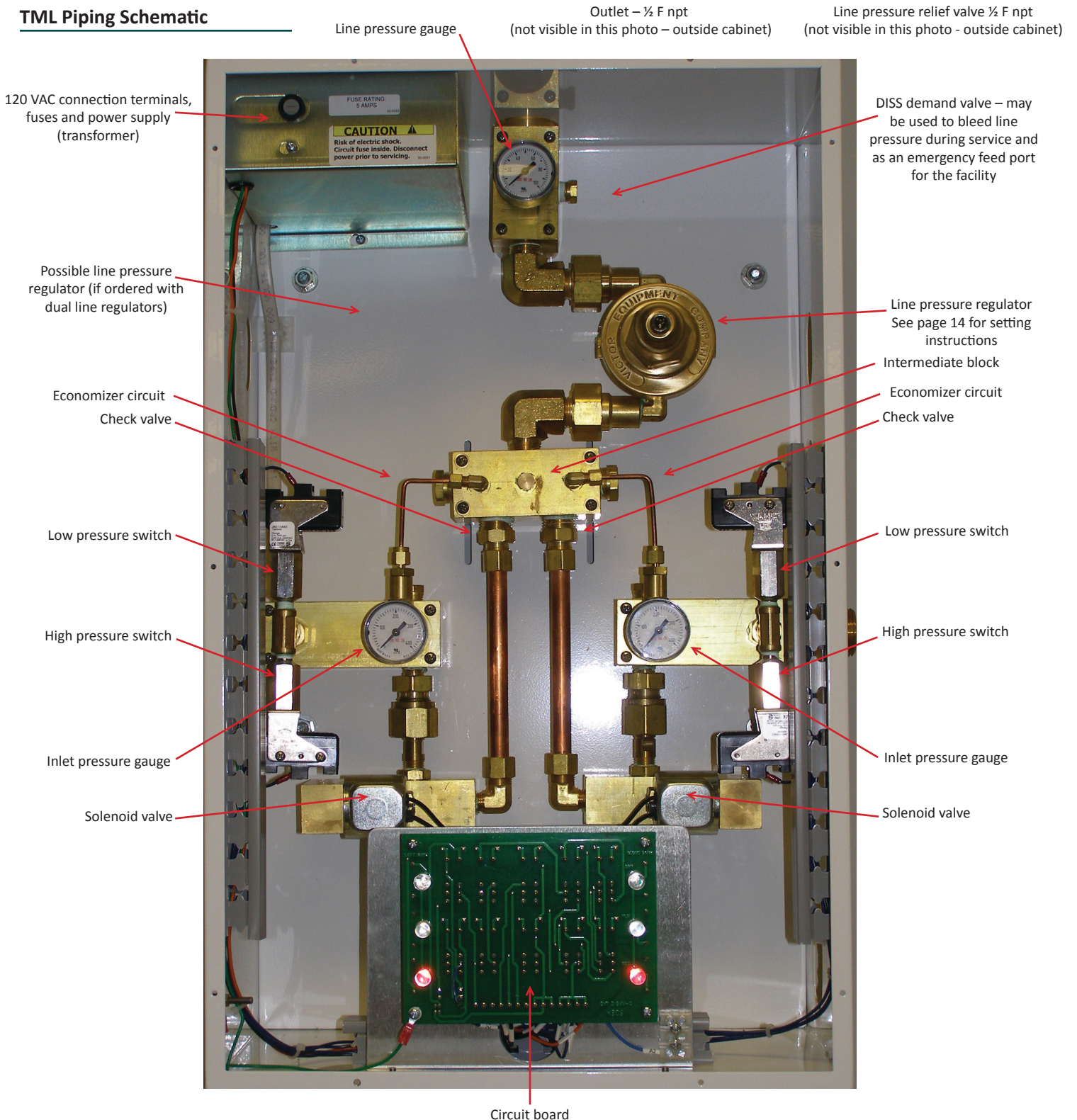

Appendix E

TML Wiring Schematic

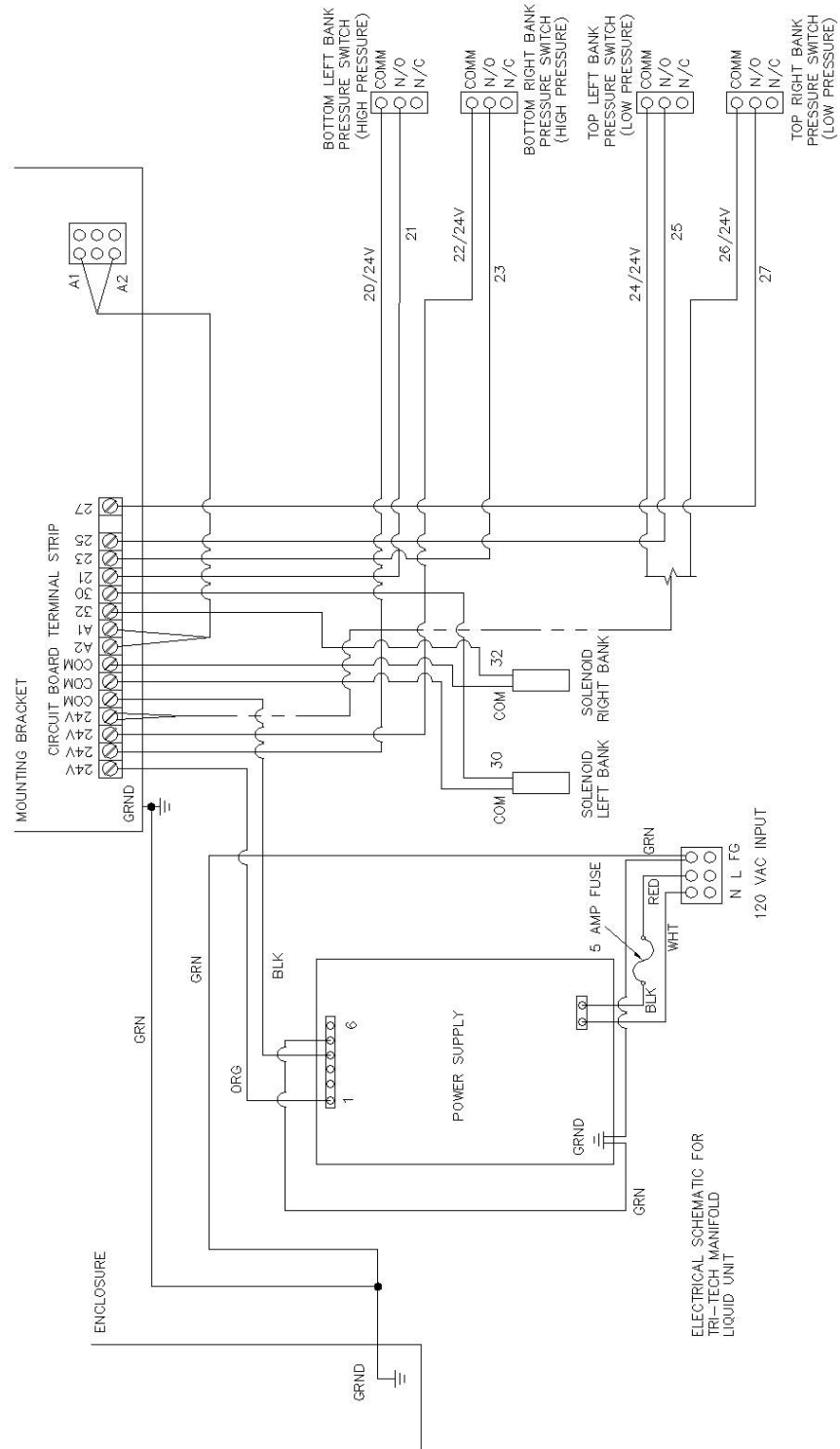

ELECTRICAL SCHEMATIC FOR
TRI-TECH MANIFOLD
LIQUID UNIT

Appendix F

TMC Heater Wiring Schematic

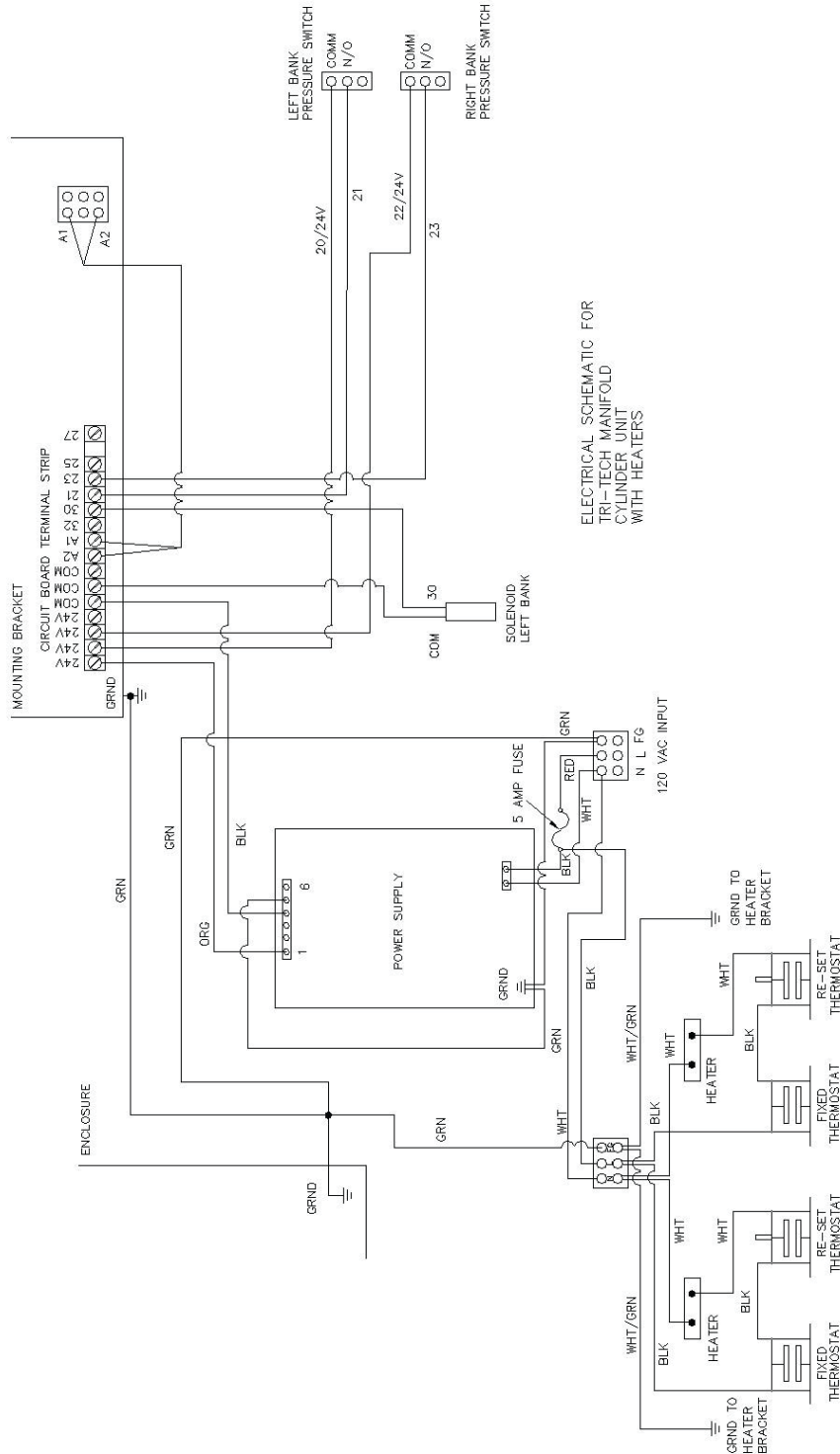

Buyer's purchase order is subject to the following conditions of sale:

Powerex Limited Warranty

Warranty and Remedies. (a) Standard Period of Warranty – Parts and Labor. Powerex warrants and represents all Products shall be free from Defects for the first twenty-four (24) months from the date of shipment by Powerex. During such warranty period, Powerex shall be fully liable for all Defects in the Products (the "Product Defects"), i.e., all costs of repair or replacement, which may include "in and out" charges, so long as the Products are located in the United States or Canada, and the Products are reasonably located and accessible by service personnel for removal. "In and out" charges include the costs of removing a Product from buyer's equipment for repair or replacement.

(b) Additional Period of Warranty – Parts Only (No Labor). In addition to the above, Powerex warrants the products described herein to be free from defects in material and workmanship for sixty (60) months from end of Standard Period of Warranty with the exception of any components which are recommended to be replaced in less than sixty months in our Installation/Operation manuals. Within said period Powerex will repair or replace any part or component which is proven to be defective in either material or workmanship. This warranty covers parts only. Labor is not included. This warranty is valid only when the product has been properly installed according to Powerex specifications, used in a normal manner and serviced according to factory recommendations. This warranty does not cover failures due to damage which occurs in shipment or failures which result from accidents, misuse, abuse, neglect, mishandling, alteration, misapplication or damage due to acts of nature.

(c) General. Powerex warrants each Powerex branded Pipeline Accessory (collectively "Products", individually each a "Product") to be free from defects in material and workmanship ("Defects") at the date of shipment. EXCEPT AS SET FORTH BELOW, NO OTHER WARRANTY, WHETHER EXPRESS OR IMPLIED, INCLUDING ANY WARRANTY OF MERCHANTABILITY OR FITNESS FOR A PARTICULAR PURPOSE, SHALL EXIST IN CONNECTION WITH THE SALE OR USE OF SUCH PRODUCTS. TO THE EXTENT PERMITTED BY LAW, ANY AND ALL IMPLIED WARRANTIES ARE EXCLUDED. All warranty claims must be made in writing and delivered to Powerex in accordance with the procedures set forth on its website (www.powerexinc.com), or such claim shall be barred. Upon timely receipt of a warranty claim, Powerex shall inspect the Product claimed to have a Defect, and Powerex shall replace any Product which it determines to have had a Defect; provided, however, that Powerex may elect, upon return of the Product, to refund to buyer any part of the purchase price of such Products paid to Powerex. Freight for returning Products to Powerex for inspection or for shipping warranty parts shall be paid by buyer where permitted by applicable law. Powerex is not responsible for any import fees, taxes, duties, licenses or other fees imposed by any governmental authority upon the production, sale, shipment and/or use of Products covered hereunder. The warranties and remedies herein are the sole and exclusive remedy for any breach of warranty or for any other claim based on any Defect, or non-performance of the Products, whether based upon contract, warranty or negligence.

(d) Coverage. The warranty provided herein applies to Powerex pipeline products only.

(e) Exceptions. Notwithstanding anything to the contrary herein, Powerex shall have no warranty obligations with respect to Products:

(i) That have not been installed in accordance with Powerex's written specifications and instructions;

(ii) That have not been maintained in accordance with Powerex's written instructions;

(iii) That have been materially modified without the prior written approval of Powerex; or

(iv) That experience failures resulting from operation, either intentional or otherwise, in excess of rated capacities or in an otherwise improper manner.

The warranty provided herein shall not apply to: **(i)** any defects arising from corrosion, abrasion, use of insoluble lubricants, or negligent attendance to or faulty operation of the Products; **(ii)** ordinary wear and tear of the Products; or **(iii)** defects arising from abnormal conditions of temperature, dirt or corrosive matter; **(iv)** any OEM component which is shipped by Powerex with the original manufacturer's warranty, which shall be the sole applicable warranty for such component.

Limitation of Liability. NOTWITHSTANDING ANYTHING TO THE CONTRARY HEREIN, TO THE EXTENT ALLOWABLE UNDER APPLICABLE LAW, UNDER NO CIRCUMSTANCES SHALL POWEREX BE LIABLE FOR ANY INCIDENTAL, CONSEQUENTIAL, PUNITIVE, SPECULATIVE OR INDIRECT LOSSES OR DAMAGES WHATSOEVER ARISING OUT OF OR IN ANY WAY RELATED TO ANY OF THE PRODUCTS OR GOODS SOLD OR AGREED TO BE SOLD BY POWEREX TO BUYER. TO THE EXTENT ALLOWABLE UNDER APPLICABLE LAW, POWEREX'S LIABILITY IN ALL EVENTS IS LIMITED TO, AND SHALL NOT EXCEED, THE PURCHASE PRICE PAID. In the event of breach of any warranty hereunder, Powerex's sole and exclusive liability shall be at its option either to repair or to replace any defective product, or to accept return, transportation prepaid, of such product and refund the purchase price; in either case provided that written notice of such defect is given to Powerex within twelve (12) months from date of shipment to Buyer, that the product is found by Powerex to have been defective at the time of such shipment, that the product has been installed and/or operated in accordance with Powerex's instructions,

that no repairs, alterations or replacements have been made by others without Powerex's written approval, and that Buyer notifies Powerex in writing within fifteen (15) days after the defect becomes apparent and promptly furnishes full particulars in connection therewith; and provided further that in no event shall the aggregate liability of Powerex in connection with breach of any warranty or warranties exceed the purchase price paid for the product purchased hereunder. Powerex may, at its option, require the return of any product, transportation and duties prepaid, to establish any claim of defect made by Buyer. Unless otherwise agreed in writing **(a)** Powerex will not accept and shall have no responsibility for products returned without its prior written consent, and **(b)** Powerex will not assume any expense or liability for repairs to products made outside of its plant by third parties. In the event Powerex elects to replace a defective product, costs of installation, labor, service, and all other costs to replace the product shall be the responsibility of Buyer.

Powerex shall not, except as set forth above, be otherwise liable to Buyer or to any person who shall purchase from Buyer, or use, any products supplied hereunder for damages of any kind, including, but not limited to, indirect, special or consequential damages or loss of production or loss of profits resulting from any cause whatsoever, including, but not limited to, any delay, act, error or omission of Powerex. Supplier's repair or replacement of any Product shall not extend the period of any warranty of any Product.

Warranty Disclaimer. Powerex has made a diligent effort to illustrate and describe the Products in its literature, including its Price Book, accurately; however, such illustrations and descriptions are for the sole purpose of identification, and do not express or imply a warranty that the Products are merchantable, or fit for a particular purpose, or that the Products will necessarily conform to the illustrations or descriptions.

Product Suitability. Many jurisdictions have codes and regulations governing sales, construction, installation, and/or use of Products for certain purposes, which may vary from those in neighboring areas. While Powerex attempts to assure that its Products comply with such codes, it cannot guarantee compliance, and cannot be responsible for how the product is installed or used. Before purchase and use of a Product, please review the Product applications, and national and local codes and regulations, and be sure that the Product, installation, and use will comply with them.

Claims. Any non-warranty claims pertaining to the Products must be filed with Powerex within (6) months of the invoice date, or they will not be honored. Prices, discounts, and terms are subject to change without notice or as stipulated in specific Product quotations. Powerex shall not be liable for any delay or failure arising out of acts of the public enemy, fire, flood, or any disaster, labor trouble, riot or disorder, delay in the supply of materials or any other cause, whether similar or dissimilar, beyond the control of Company. All shipments are carefully inspected and counted before leaving the factory. Please inspect carefully any receipt of Products noting any discrepancy or damage on the carrier's freight bill at the time of delivery. Discrepancies or damage which obviously occurred in transit are the carrier's responsibility and related claims should be made promptly directly to the carrier. Returned Products will not be accepted without prior written authorization by Powerex and deductions from invoices for shortage or damage claims will not be allowed. **UNLESS OTHERWISE AGREED TO IN WRITING, THE TERMS AND CONDITIONS CONTAINED IN THIS LIMITED WARRANTY WILL CONTROL IN ANY TRANSACTION WITH POWEREX.** Any different or conflicting terms as may appear on any order form now or later submitted by the buyer will not control. All orders are subject to acceptance by Powerex.

